

**17 inch Wide Screen
TFT LCD Monitor**



**iB171
USER'S MANUAL**

Before operating the monitor, please read this manual thoroughly. This manual should be retained for future reference.

FCC Class B Radio Frequency Interference Statement

This equipment has been tested and found to comply with the limits for a Class B digital device, pursuant to Part 15 of the FCC Rules. These limits are designed to provide reasonable protection against harmful interference in a residential installation. This equipment generates, uses and can radiate radio frequency energy, and if not installed and used in accordance with the instructions, may cause harmful interference to radio communications. However, there is no guarantee that interference will not occur in a particular installation. If this equipment does cause harmful interference to radio or television reception, which can be determined by turning the equipment off and on, the user is encouraged to try to correct the interference by one or more of the following measures:

- Reorient or relocate the receiving antenna.
- Increase the separation between the equipment and receiver.
- Connect the equipment into an outlet on a circuit different from that to which the receiver is connected.
- Consult the dealer or an experienced radio/TV technician for help.

The device complies with Parts 15 of the FCC Rule. Operation is subject to the following two conditions : (1) this device may not cause harmful interference ; and (2) this device must accept any interference received, including interference that may cause undesired operations.

CANADA

This Class B digital apparatus meets all requirements of the Canadian Interference-Causing Equipment Regulation.



This device complies with requirement of EMC directive 89/336/EEC with regard to Electromagnetic Compatibility, and 73/23/EEC and 93/68/EEC with regard to Low Voltage directive.

Socket-outlet shall be near the equipment and shall be accessible.

TABLE OF CONTENTS

| | |
|---|-----------|
| SAFETY NOTICE | 4 |
| PRECAUTIONS | 4 |
| SPECIAL NOTES ON LCD MONITORS | 5 |
| BEFORE YOU OPERATE THE MONITOR | 6 |
| FEATURES | 6 |
| CHECKING THE CONTENTS OF THE PACKAGE | 6 |
| INSTALLATION INSTRUCTIONS | 7 |
| POWER..... | 7 |
| MAKING CONNECTIONS..... | 8 |
| ADJUSTING THE VIEWING ANGLE | 9 |
| OPERATING INSTRUCTIONS..... | 10 |
| GENERAL INSTRUCTIONS..... | 10 |
| FRONT PANEL CONTROL | 11 |
| HOW TO ADJUST A SETTING | 12 |
| PLUG AND PLAY | 15 |
| TECHNICAL SUPPORT (FAQ)..... | 16 |
| Q & A FOR GENERAL PROBLEMS..... | 16 |
| ERROR MESSAGE & POSSIBLE SOLUTIONS | 17 |
| APPENDIX | 18 |
| SPECIFICATIONS | 18 |

SAFETY NOTICE

1. The changes or modifications not expressly approved by the party responsible for compliance could void the user's authority to operate the equipment.
2. Shielded interface cables and AC power cord, if any, must be used in order to comply with the emission limits.
3. The manufacturer is not responsible for any radio or TV interference caused by unauthorized modification to this equipment. It is the responsibilities of the user to correct such interference.

WARNING:

To prevent fire or shock hazard, do not expose the monitor to rain or moisture. Dangerously high voltages are present inside the monitor. Do not open the cabinet. Refer servicing to qualified personnel only.

PRECAUTIONS

- Do not use the monitor near water, e.g. near a bathtub, washbowl, kitchen sink, laundry tub, swimming pool or in a wet basement.
- Do not place the monitor on an unstable cart, stand, or table. If the monitor falls, it can injure a person and cause serious damage to the appliance. Use only a cart or stand recommended by the manufacturer or sold with the monitor. If you mount the monitor on a wall or shelf, use a mounting kit approved by the manufacturer and follow the kit instructions.
- Slots and openings in the back and bottom of the cabinet are provided for ventilation. To ensure reliable operation of the monitor and to protect it from overheating, be sure these openings are not blocked or covered. Do not place the monitor on a bed, sofa, rug, or similar surface. Do not place the monitor near or over a radiator or heat register. Do not place the monitor in a bookcase or cabinet unless proper ventilation is provided.
- The monitor should be operated only from the type of power source indicated on the label. If you are not sure of the type of power supplied to your home, consult your dealer or local power company.
- Unplug the unit during a lightning storm or when it will not be used for long period of time. This will protect the monitor from damage due to power surges.
- Do not overload power strips and extension cords. Overloading can result in fire or electric shock.
- Never push any object into the slot on the monitor cabinet. It could short circuit parts causing a fire or electric shock. Never spill liquids on the monitor.
- Do not attempt to service the monitor by yourself; opening or removing covers can expose you to dangerous voltages and other hazards. Please refer all servicing to qualified service personnel.
- The wall socket shall be installed near the equipment and shall be easily accessible.

SPECIAL NOTES ON LCD MONITORS

The following symptoms are normal with LCD monitor and do not indicate a problem.

- Due to the nature of the fluorescent light, the screen may flicker during initial use. Turn off the Power Switch and then turn it on again to make sure the flicker disappears.
- You may find slightly uneven brightness on the screen depending on the desktop pattern you use.
- The LCD screen has effective pixels of 99.99% or more. It may include blemishes of 0.01% or less such as a missing pixel or a pixel lit all of the time.
- Due to the nature of the LCD screen, an afterimage of the previous screen may remain after switching the image, when the same image is displayed for hours. In this case, the screen is recovered slowly by changing the image or turning off the Power Switch for hours.
- If the screen suddenly flashes erratically or the backlighting fails, please contact your dealer or service center for repair. Do not attempt to repair the monitor yourself.

Lamp Disposal



LAMP(S) INSIDE THIS PRODUCT CONTAIN MERCURY AND MUST BE RECYCLED OR DISPOSED OF ACCORDING TO LOCAL, STATE OR FEDERAL LAWS. FOR MORE INFORMATION, CONTACT THE ELECTRONIC INDUSTRIES ALLIANCE AT WWW.EIAE.ORG. FOR LAMP SPECIFIC DISPOSAL INFORMATION CHECK WWW.LAMPRECYCLE.ORG.

BEFORE YOU OPERATE THE MONITOR

FEATURES

- 17" Wide screen TFT Color LCD Monitor
- Crisp, Clear Display for Windows
- Recommended Resolutions: 1440 X 900 @60Hz
- EPA ENERGY STAR®
- Ergonomic Design
- Space Saving, Compact Case Design

CHECKING THE CONTENTS OF THE PACKAGE

The product package should include the following items:

LCD Monitor

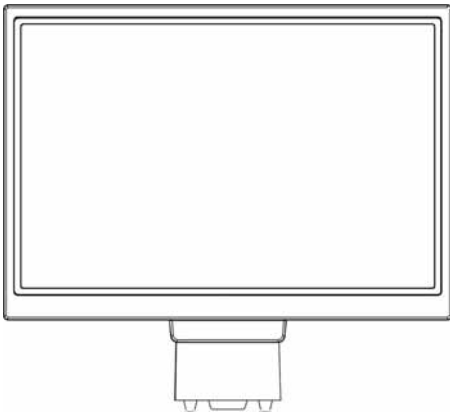

Screen

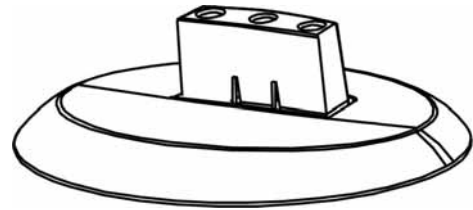

Base

Cables and User manual

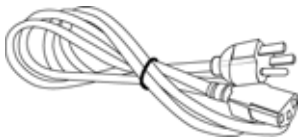

Power Cord

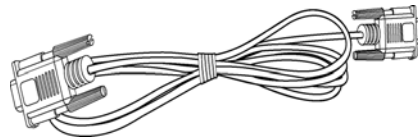

VGA Cable



DVI-D Cable (dual input mode optional)



User's manual

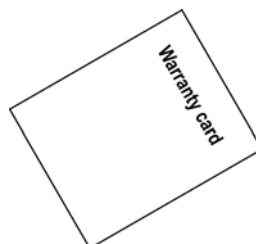

Warranty card

INSTALLATION INSTRUCTIONS

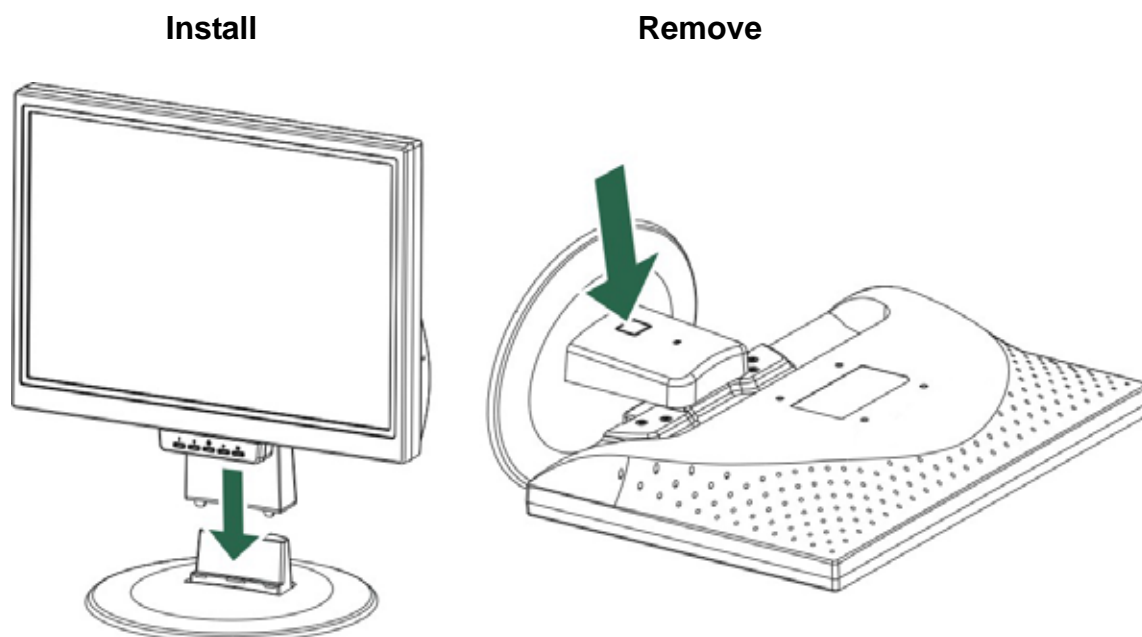

Figure.1. Installing and Removing the Base

INSTALLATION:

1. Align the monitor with the opening in the base.
2. Note that the longer section of the base points forward.
3. Snap the monitor into its base. A clear click sound will affirm that the base is connected correctly.
4. Verify that the monitor is securely attached to the base by looking at the bottom of the base and making sure that the clips are fully engaged in the base.

REMOVAL:

1. Flip over the monitor so that it is upside down.
2. Press the button on the arm that holds the monitor in place.
3. Gently pull the base from the monitor until they are unattached.

POWER

POWER SOURCE:

1. Make sure that the power cord is the correct type required in your area.
2. This LCD monitor has an Internal universal power supply that allows operation in either 100/120V AC or 220/240V AC voltage area (No user adjustment is required.)
3. Connect the AC-power cord one end to your LCD monitor's AC-input socket, the other end to wall-outlet .

MAKING CONNECTIONS

CONNECTING TO A PC

Turn off your computer before performing the procedure below.

1. Connect one end of the D-Sub cable to the back of the monitor and connect the other end to the computer's D-Sub port.
2. Connect one end of the DVI-D cable (Dual input mode optional) to the back of the monitor and connect the other end to the computer's DVI-D port.
3. Plug one end of the AC power cord to the LCD monitor's AC input socket, and the other end to Wall outlet.
4. Turn on your monitor and computer.

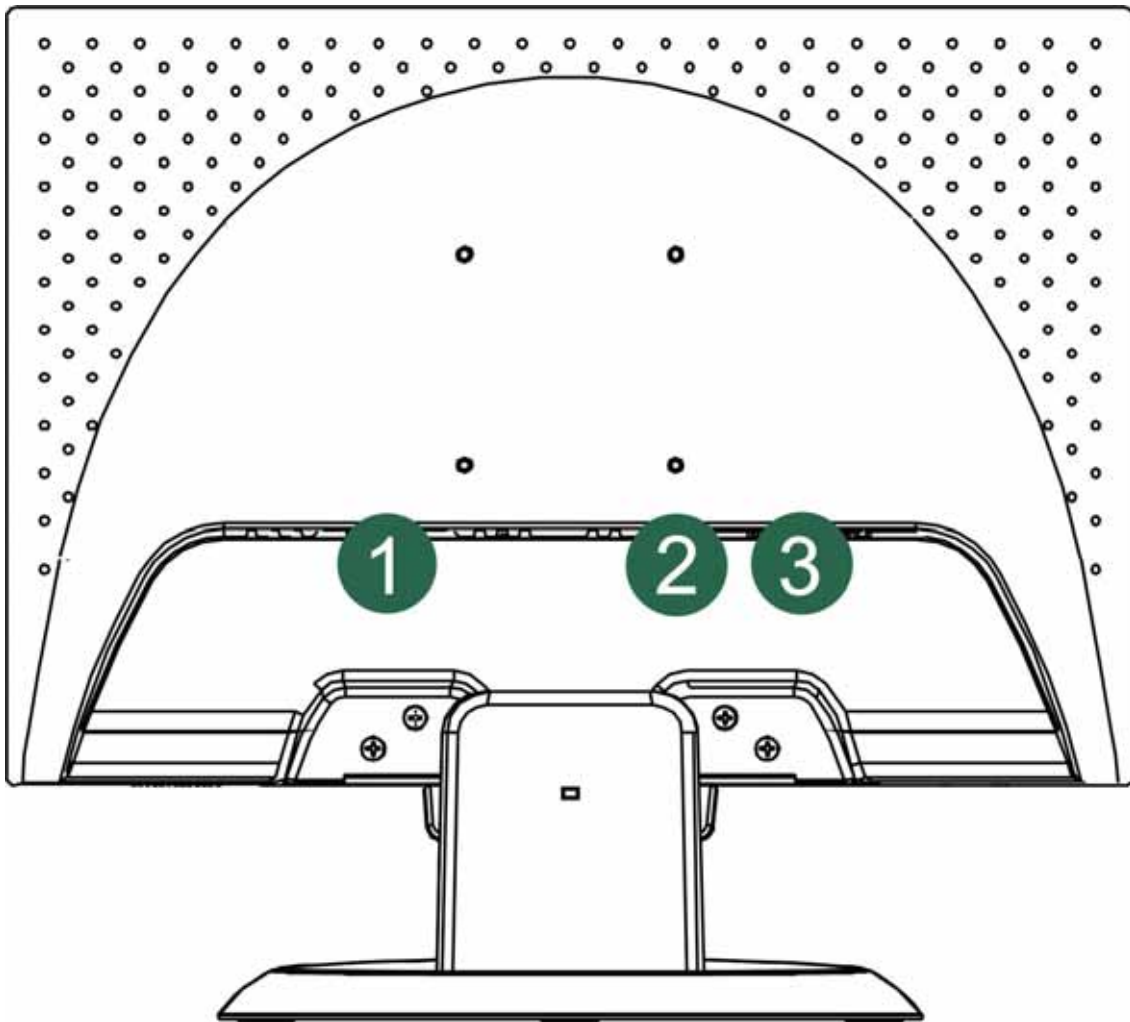

Figure.2. Connecting to a PC

| | | | |
|----|----------------|----|------------------------|
| 1. | Power AC Input | 2. | DVI-D Input (optional) |
| 3. | VGA Input | | |

ADJUSTING THE VIEWING ANGLE

- For optimal viewing it is recommended to look at the full face of the monitor, then adjust the monitor's angle to your own preference.
- Hold the stand so you do not topple the monitor when you change the monitor's angle.
- You are able to adjust the monitor's angle from 0° to 20° .

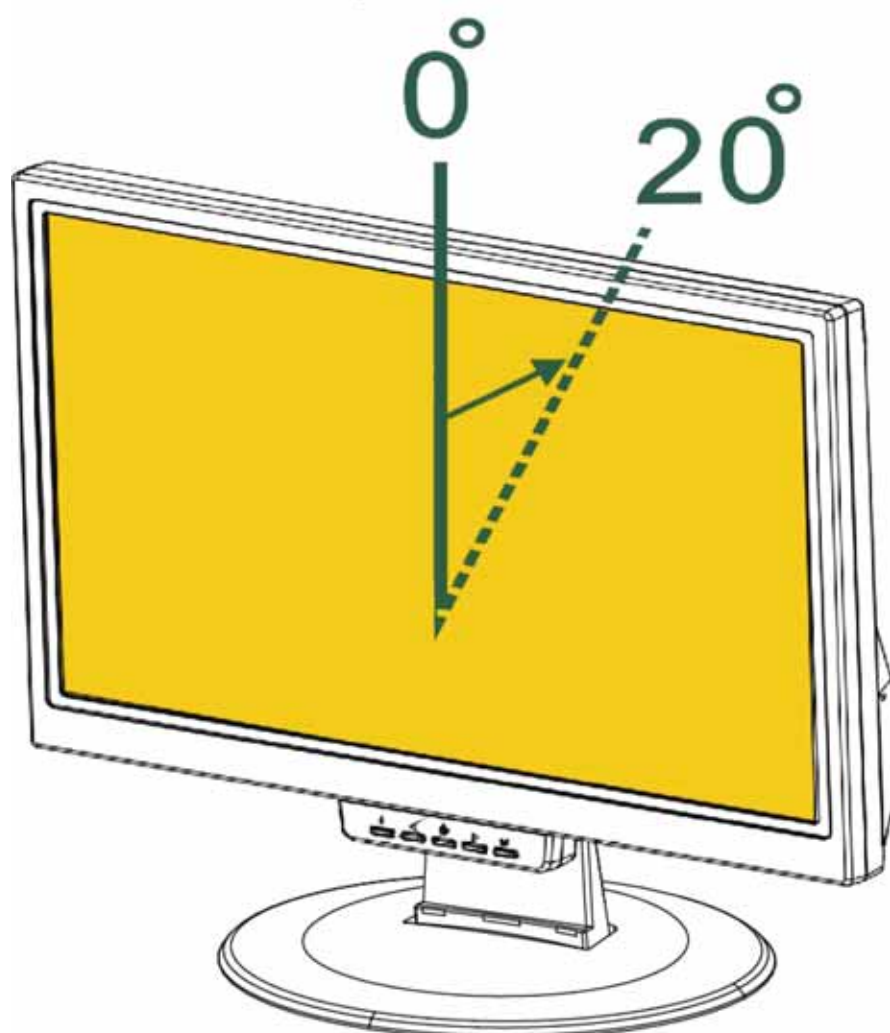

Figure.3. Monitor Angle

NOTES:

- Do not touch the LCD screen when you change the angle. It may cause damage or break the LCD screen.
- Be careful not to place fingers or hands near the hinges when tilting the monitor, otherwise pinching can result.

OPERATING INSTRUCTIONS

GENERAL INSTRUCTIONS

Press the power button to turn the monitor on or off. The other control buttons are located on the front panel of the monitor (See Figure 4). By changing these settings, the picture can be adjusted to your personal preferences.

- The power cord should be connected.
- Connect the Signal cable from the monitor to the VGA card.
- Press the power button to turn on the monitor. The power indicator will light up.

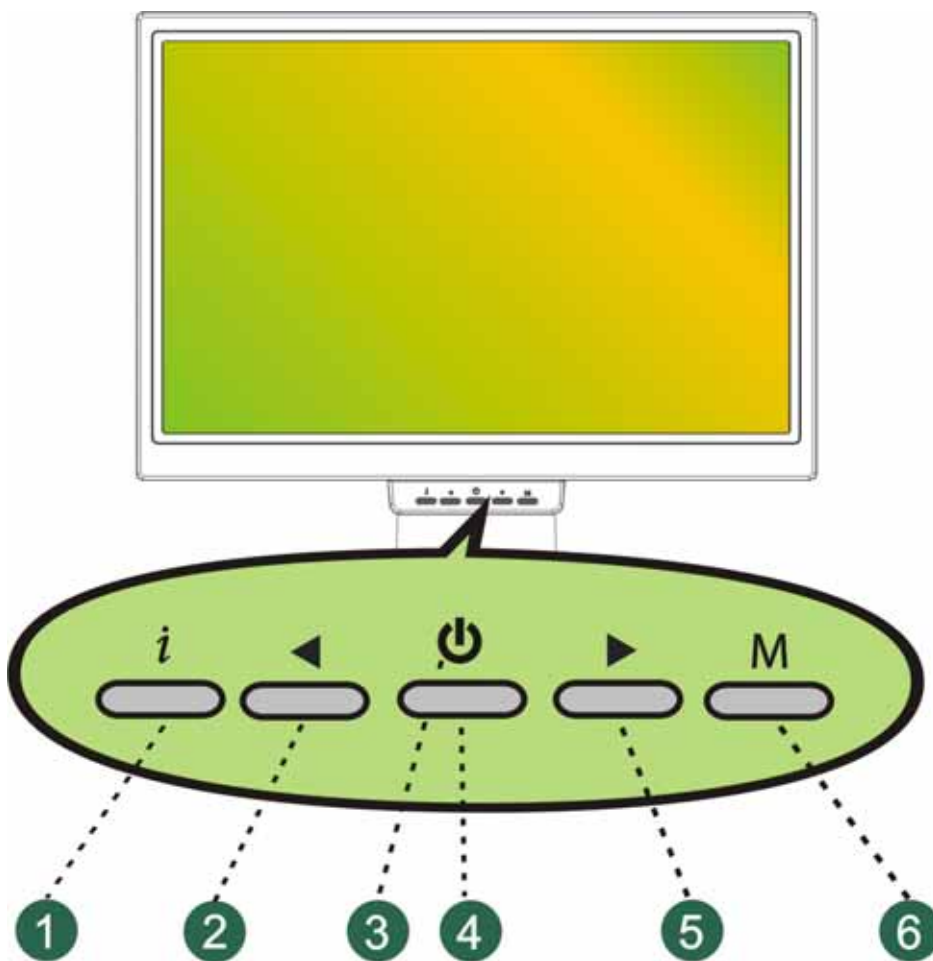

Figure.4. Control Panel Buttons

CONTROL PANEL BUTTONS:

| | | | |
|----|-----------------|----|--------------|
| 1. | i Button | 2. | Adjust < |
| 3. | Power Indicator | 4. | Power Button |
| 5. | Adjust > | 6. | Menu / Enter |

FRONT PANEL CONTROL

- **Power Button:**
Press this button to switch ON/OFF of monitor's power.
- **Power Indicator:**
Green — Power On mode.
Orange — Power Saving mode.
- **MENU / ENTER:**
Activates the OSD menu or confirms adjustments to settings.
- **Adjust < >:**
Navigate through adjustment icons when OSD is ON or adjust a function when function is activated.
- **i Button: (for D-sub only)**
When OSD menu is in off status, press and hold this button for more than two seconds to activate the Auto Adjustment function.
(The Auto Adjustment function is used to optimized the H-Position, V-Position, Clock and Phase.)

NOTES:

- Do not install the monitor in a location near heat sources such as radiators or air ducts, or in a place subject to direct sunlight, or excessive dust or mechanical vibration or shock.
- Save the original shipping box and packing materials, as they will come in handy if you ever have to ship your monitor.
- For maximum protection, repackage your monitor as it was originally packed at the factory.
- To keep the monitor looking new, periodically clean it with a soft cloth. Stubborn stains may be removed with a cloth lightly dampened with a mild detergent solution. Never use strong solvents such as thinner, benzene, or abrasive cleaners, since these will damage the cabinet. As a safety precaution, always unplug the monitor before cleaning it.
- **Function Key Lock:**
Press the 「<」, 「>」 and the 「**Menu**」 buttons simultaneously to enable the Function Key Lock. When the Function Key Lock is enabled, only the Power button is active. Press the 「<」, 「>」 and the 「**Menu**」 buttons simultaneously again to unlock the function keys.

HOW TO ADJUST A SETTING

Main Menu

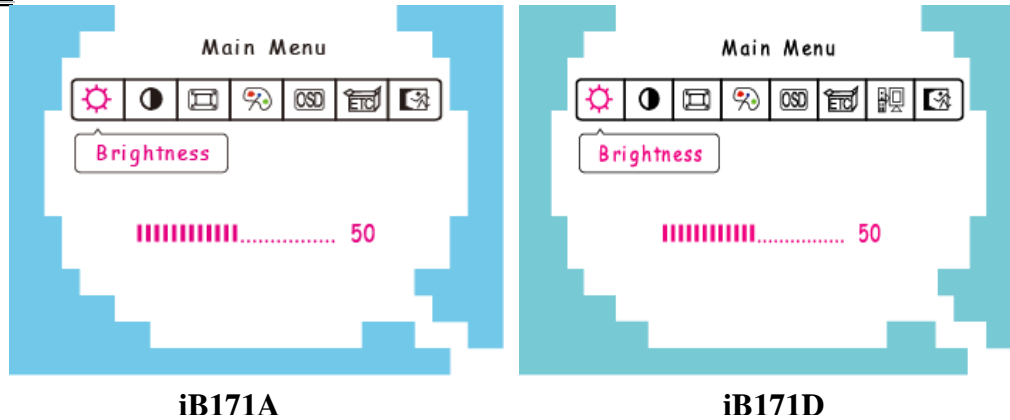

| FUNCTION | DESCRIPTION |
|---------------|---|
| Brightness | Select the 「Brightness」 option on the 「Main Menu」. Enter the option by pressing the 「Menu」 button again, and adjust the level. |
| Contrast | Select the 「Contrast」 option on the 「Main Menu」. Enter the option by pressing the 「Menu」 button again, and adjust the level. |
| Image Setting | Select the 「Image Setting」 option on the 「Main Menu」, and then enter the option. |
| Color Setting | Select the 「Color Setting」 option on the 「Main Menu」, and then enter the option. |
| OSD Setting | Select the 「OSD Setting」 option on the 「Main Menu」, and then enter the option. |
| Other Setting | Select the 「Other Setting」 option on the 「Main Menu」, and then enter the option. |
| Input Setting | Select the 「Input Setting」 option to change between the analog (D-Sub) or Digital (DVI) source. Enter the option and select Analog or Digital. (Dual input mode optional) |
| Exit | Exit the OSD menu function. |

Image Setting

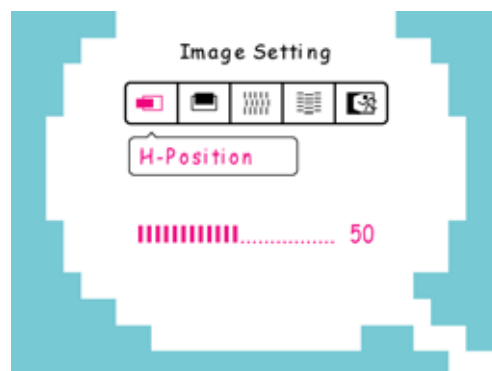

| FUNCTION | DESCRIPTION |
|------------|---|
| H-position | Select the 「H-position」 option to shift the screen image to the left or right. Enter the option and adjust the level. |

| | |
|------------------|---|
| V-position | Select the 「V-position」 option to shift the screen image up or down. Enter the option and adjust the level. |
| Clock Adjustment | Select the 「Clock Adjustment」 option to reduce the vertical flicker of characters on the screen. Enter the option and adjust the level. |
| Phase Adjustment | Select the 「Phase Adjustment」 option to reduce the horizontal flicker of characters on the screen. Enter the option and adjust the level. |
| Exit | Exit the OSD menu function. |

Color Setting

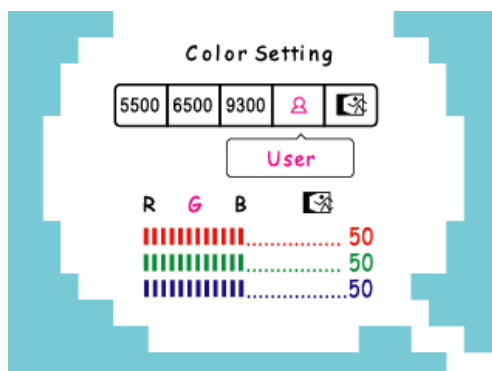

| FUNCTION | DESCRIPTION |
|-------------------|---|
| 5500K/6500K/9300K | Move the cursor to one of the preset options and select it. |
| User | Move the cursor to the User option and select it 1. To adjust the red, enter the 「R」 option and adjust the level. 2. To adjust the green, enter the 「G」 option and adjust the level. 3. To adjust the blue, enter the 「B」 option and adjust the level. |
| Exit | Exit the OSD menu function. |

OSD Setting

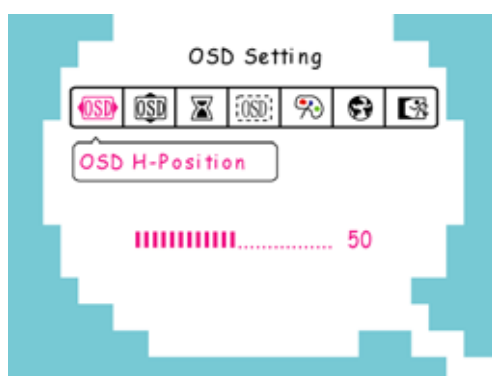

| FUNCTION | DESCRIPTION |
|----------------|---|
| OSD H-Position | Select the 「OSD H-Position」 option to adjust the horizontal position of the OSD. Enter the option and adjust the level. |
| OSD V-position | Select the 「OSD V-Position」 option to adjust the vertical position of the OSD. Enter the option and adjust the level. |
| OSD Time-out | Select the 「OSD Time-out」 option to set the OSD time out from 10 to 120 seconds. Enter the option and adjust the level. |

User's Manual

| | |
|------------------|---|
| OSD Transparency | Select the 「 OSD Transparency 」 option to adjust the transparency of the OSD. Enter the option and adjust the level. |
| OSD Color | Select the 「 OSD Color 」 setting option to adjust the color of the OSD. Enter the option and adjust the level. |
| Language | Select the 「 Language 」 option to change the language of the OSD. Enter the option and select a language. (Reference only, the OSD Language is depended on selected model) |
| Exit | Exit the OSD menu function. |

Other Setting

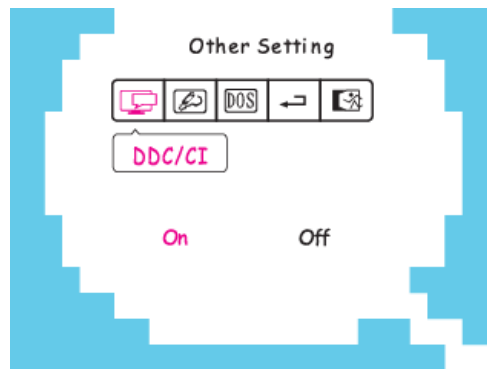

| FUNCTION | DESCRIPTION |
|----------------|--|
| DDC/CI | Select the 「 DDC/CI 」 option to switch the function On or Off. (dual input mode optional) |
| Sharpness | Select the 「 Sharpness 」 option to adjust the sharpness of the display. Set the value from 0 to 6. |
| DOS mode | Select the 「 DOS mode 」 option to set the monitor for use with PC. Enter the option and select 720 x 400 or 640 x 400. |
| Factory Preset | Select the 「 Factory Preset 」 option to reset to the monitor's default setting. This will erase the current settings. Enter the option and select On or Off. |
| Exit | Exit the OSD menu function. |

PLUG AND PLAY

Plug & Play DDC2B Feature

This monitor is equipped with VESA DDC2B capabilities according to the VESA DDC STANDARD. It allows the monitor to inform the host system of its identity and, depending on the level of DDC used, communicate additional information about its display capabilities. The DDC2B is a bidirectional data channel based on the I²C protocol. The host can request EDID information over the DDC2B channel.

THIS MONITOR WILL APPEAR TO BE NON-FUNCTIONAL IF THERE IS NO VIDEO INPUT SIGNAL. IN ORDER FOR THIS MONITOR TO OPERATE PROPERLY, THERE MUST BE A VIDEO INPUT SIGNAL.

This monitor meets the Green monitor standards as set by the Video Electronics Standards Association (VESA) and/or the United States Environmental Protection Agency (EPA) and The Swedish Confederation Employees (NUTEK). This feature is designed to conserve electrical energy by reducing power consumption when there is no video-input signal present. When there is no video input signal this monitor, following a time-out period, will automatically switch to power saving mode. This reduces the monitor's internal power supply consumption. After the video input signal is restored, full power is restored and the display is automatically redrawn. The appearance is similar to a "Screen Saver" feature except the display is completely off. The display is restored by pressing a key on the keyboard, or clicking the mouse.

TECHNICAL SUPPORT (FAQ)

Q & A FOR GENERAL PROBLEMS

| PROBLEM & QUESTION | POSSIBLE SOLUTION |
|--|--|
| Power LED is not on | <ul style="list-style-type: none"> *Check if the Power Switch is in the ON position *Power Cord should be connected |
| No Plug & Play | <ul style="list-style-type: none"> *Check if the PC system is Plug & Play compatible *Check if the Video Card is Plug & Play compatible *Check if any plug pins on the D-Sub or DVI-D connector are bent |
| The display is too dark or too bright. | <ul style="list-style-type: none"> *Adjust the Contrast and Brightness Controls. |
| Picture bounces or a wave pattern is present in the picture | <ul style="list-style-type: none"> *Move electrical devices that may cause electrical interference. |
| The power LED is ON (orange) but there's no video or no picture. | <ul style="list-style-type: none"> *Computer Power Switch should be in the ON position. *Computer Video Card should be snugly seated in its slot *Make sure monitor's video cable is properly connected to the computer. *Inspect monitor's video cable and make sure none of the pins are bent. *Make sure computer is operational by hitting the CAPS LOCK key on the keyboard while observing the CAPS LOCK LED. The LED should either turn ON or OFF after hitting the CAPS LOCK key. |
| Missing one of the primary colors (RED, GREEN, or BLUE) | <ul style="list-style-type: none"> *Inspect the monitor's video cable and make sure that none of the pins are bent. |
| Screen image is not centered or sized properly. | <ul style="list-style-type: none"> * Adjust pixel frequency CLOCK and PHASE or press hot-key (i Button) |
| Picture has color defects (white does not look white) | <ul style="list-style-type: none"> *Adjust RGB color or select color temperature |
| The screen resolution needs to be adjusted | <ul style="list-style-type: none"> *Use win 2000/ME/XP Right click anywhere on desktop and select Properties>Settings>Screen Resolution. Use the slider to adjust the resolution and click Apply |

ERROR MESSAGE & POSSIBLE SOLUTIONS

- **CABLE NOT CONNECTED :**
 1. Check that the signal-cable is properly connected, If the connector is loose, tighten the connector's screws.
 2. Check the signal-cable's connection pins for damage.
- **INPUT NOT SUPPORT :**
Your computer has been set to unsuitable display mode, set the computer to display mode given in the following table.

FACTORY PRESET TIMING TABLE:

| MODE | RESOLUTION | HORIZONTAL FREQUENCY (KHz) | VERTICAL FREQUENCY (Hz) |
|------|-----------------|----------------------------|-------------------------|
| 1 | 640x350 @70Hz | 31.469 | 70.087 |
| 2 | 640x400 @56Hz | 24.827 | 56.424 |
| 3 | 640x400 @70Hz | 31.469 | 70.090 |
| 4 | 640x480 @60Hz | 31.469 | 59.940 |
| 5 | 640x480 @67Hz | 35.000 | 66.667 |
| 6 | 640x480 @72Hz | 37.861 | 72.809 |
| 7 | 640x480 @75Hz | 37.500 | 75.000 |
| 8 | 720x400 @70Hz | 31.469 | 70.087 |
| 9 | 800x600 @56Hz | 35.156 | 56.250 |
| 10 | 800x600 @60Hz | 37.879 | 60.317 |
| 11 | 800x600 @72Hz | 48.077 | 72.188 |
| 12 | 800x600 @75Hz | 46.875 | 75.000 |
| 13 | 832x624 @74.6Hz | 49.725 | 74.500 |
| 14 | 1024x768 @60Hz | 48.363 | 60.004 |
| 15 | 1024x768 @66Hz | 53.964 | 66.132 |
| 16 | 1024x768 @70Hz | 56.476 | 70.069 |
| 17 | 1024x768 @75Hz | 60.023 | 75.029 |
| 18 | 1024x768 @75Hz | 60.150 | 74.720 |
| 19 | 1152x864 @75Hz | 67.500 | 75.000 |
| 20 | 1152x870 @75Hz | 68.681 | 75.062 |
| 21 | 1152x900 @66Hz | 61.846 | 66.004 |
| 22 | 1280x720 @60Hz | 45.000 | 60.000 |
| 23 | 1280x768 @60Hz | 47.776 | 59.870 |
| 24 | 1280x960 @60Hz | 60.000 | 60.000 |
| 25 | 1280x1024 @60Hz | 63.981 | 60.020 |
| 26 | 1280x1024 @75Hz | 79.976 | 75.025 |
| 27 | 1360x768 @60Hz | 47.712 | 60.015 |
| 28 | 1400x1050 @60Hz | 64.744 | 59.948 |
| 29 | 1400x1050 @60Hz | 65.317 | 59.978 |
| 30 | 1400x1050 @75Hz | 82.278 | 74.867 |
| 31 | 1440x900 @60Hz | 55.469 | 59.901 |
| 32 | 1440x900 @60Hz | 55.935 | 59.887 |
| 33 | 1440x900 @75Hz | 70.635 | 74.984 |

APPENDIX

SPECIFICATIONS

| | | |
|------------------------------|-------------------|---|
| LCD Panel | Driving system | TFT Color LCD |
| | Size | 17.0" |
| | Pixel pitch | 0.255mm(H) x 0.255mm(V) |
| Video | H-Frequency | 24KHz – 80KHz |
| | V-Frequency | 55 – 75Hz |
| Display Colors | | 16.2M Colors |
| Maximum Screen Size | | Hor. :367.2mm Ver. :229.5mm |
| Max. Resolution | | 1440 x 900 @75Hz |
| Plug & Play | | VESA DDC2B™ |
| EPA ENERGY STAR® | ON Mode | 36W |
| | Power Saving Mode | 2W |
| | OFF Mode | 1W |
| Input Terminal | | D-Sub DVI-D (Dual-Input Model) |
| Power Source | | 100~240VAC,50±3Hz,60±3Hz |
| Environmental Considerations | | Operating Temp: 5° to 35°C Storage Temp.: -20° to 60°C Operating Humidity: 10% to 85% |
| Dimensions | | 360(W)×400(H)×185(D) mm 14.2”(W)×15.7”(H)×7.3”(D) |
| Weight (NW) | | 2.9 kg (6.4 lb) |

***The above specification is subject to actual product specification and is subject to change without prior notice.